

TravelMate P215-52/P215-52G

# LIFECYCLE EXTENSION GUIDE

Disassembly Procedures . . . . .	1-1
Troubleshooting . . . . .	1-38
FRU (Field Replaceable Unit) List . . . . .	1-39
Exploded Diagrams . . . . .	1-40
Software Update . . . . .	1-43
Personal Data Removal . . . . .	1-44

# Disassembly Procedures

---

## Safety Guidelines

---

This chapter contains step by step procedures on how to remove and de-install components from the computer. Use the following safety guidelines to ensure your personal safety. Each procedure included in this chapter assumes that you are preparing your computer for recycling and disposal. **By performing any of these procedures you acknowledge that any remaining warranty applicable to your computer will be voided. Before you start any of the procedures in this chapter, make sure to read the following safety guidelines and the respective instructions within the chapter.**

### CAUTION!

- Turn off your computer and disconnect all power sources before opening the computer cover or panels.
- To avoid electrostatic discharge, ground yourself by using a wrist grounding strap or by periodically touching an unpainted metal surface at the same time as touching a connector on the back of the computer.
- Take off any metal objects on your arms or fingers such as bracelets, rings or watches and make sure your hands are completely dry. Even if your unit is unplugged, there may still be some remaining electric charge.
- If a component does not come out easily, do not forcefully remove it. Instead, check that you are removing it correctly and that no wires or other parts are in the way.
- When you disconnect a cable, pull on its connector or on its pull-tab, not on the cable itself. Some cables have connectors with locking tabs; if you are disconnecting this type of cable, press in on the locking tabs before you disconnect the cable.

## Recommended Equipment

---

The following equipment are recommended to do the following maintenance procedures:

- Wrist grounding strap and conductive mat
- Philips screwdriver
- Plastic tweezers
- Flat plastic pry

# WEEE Annex VII Component

---

These components are classified as requiring selective treatment:

- Battery pack
- WLAN module
- DIMM modules
- SSD module
- LTE module
- Touchpad module
- Mainboard
- RTC battery
- LCD panel

# Pre-disassembly Instructions

---

Do the following prior to starting any maintenance procedures:

1. Place the system on a stable work surface.
2. Remove AC adapter (A) from the system and peripherals (Figure 1-1).
3. Remove all cables from system.



---

**Figure 1-1. AC Adapter Outlet**

4. Remove the SD card from the SD card slot (B) (Figure 1-2).



---

**Figure 1-2. SD Card Removal**

**⇒ NOTE:**

Make sure the system is completely powered off.

## Base Cover Removal

---

1. Remove twelve (12) screws from the base cover (Figure 1-3).



---

**Figure 1-3. Base Cover Removal**

2. Carefully pry up the base cover starting from the upper side to release the latches. Then continue releasing the remaining latches on the left, right, and bottom sides (Figure 1-4).



---

**Figure 1-4. Base Cover Removal**

3. Grasp and remove the base cover from the system (Figure 1-5).



**Figure 1-5. Base Cover Removal**

# Battery Pack Removal

---

## Prerequisite:

### Base Cover Removal

1. Find the battery pack (A) in the system (Figure 1-6).
2. Detach the tape (B) securing the battery cable to the mainboard connector (Figure 1-6).
3. Detach the transparent mylar (C) securing the fan and battery cables (Figure 1-6).

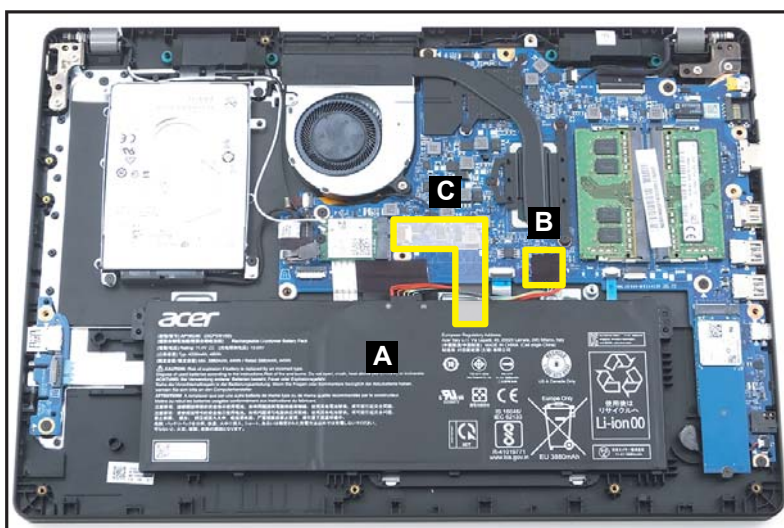

Figure 1-6. Battery Pack Removal

4. Disconnect the battery cable from the mainboard connector (D) (Figure 1-7).

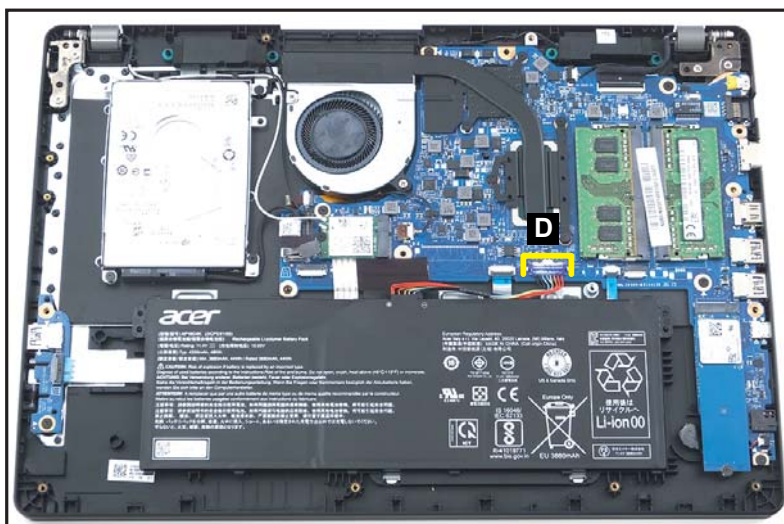
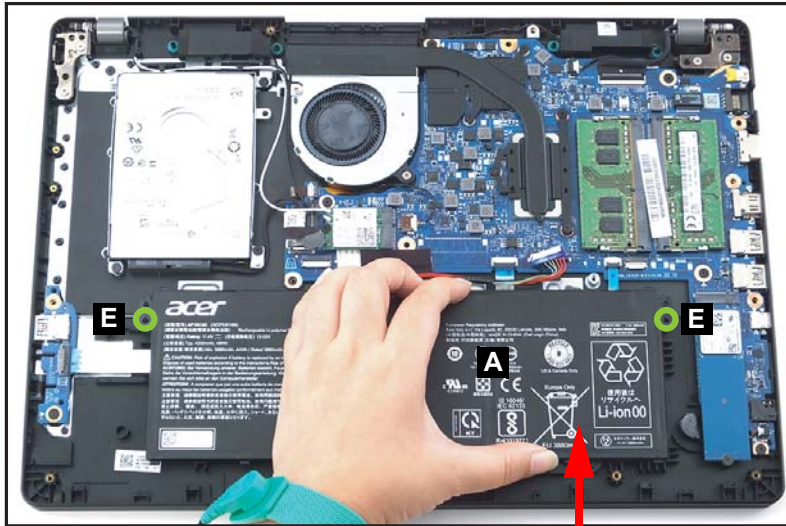

Figure 1-7. Battery Pack Removal



5. Release the battery pack from the guide pins (E) and remove the battery pack (A) from the system (Figure 1-8).



WEEE Annex VII Component: Battery Pack

Figure 1-8. Battery Pack Removal

- + **IMPORTANT:** Follow local regulations for battery disposal.

# WLAN Module Removal

---

## Prerequisite:

### Battery Pack Removal

1. Find the WLAN module (A) on the top assembly (Figure 1-9).

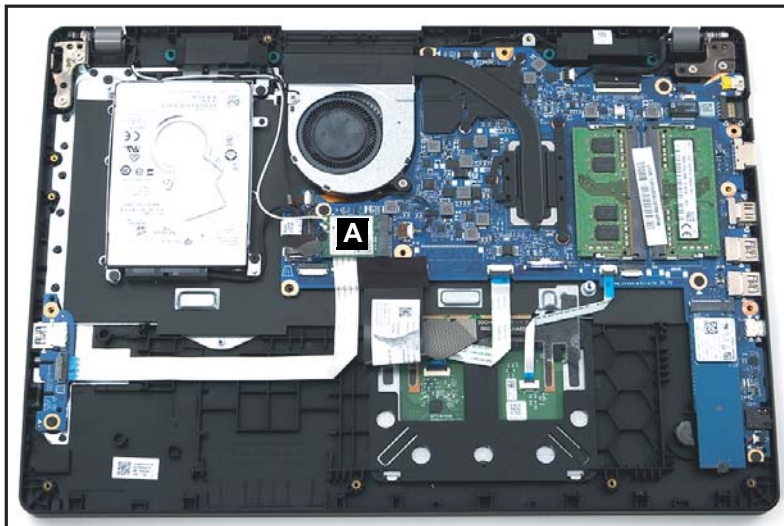

Figure 1-9. WLAN Module Location

2. Disconnect the WLAN antennas cables from the WLAN module connectors (B) (Figure 1-10). Then remove the WLAN antennas cables (C) from the cable guides as shown in Figure 1-10.
3. Remove one (1) screw securing the WLAN module in place (Figure 1-10).

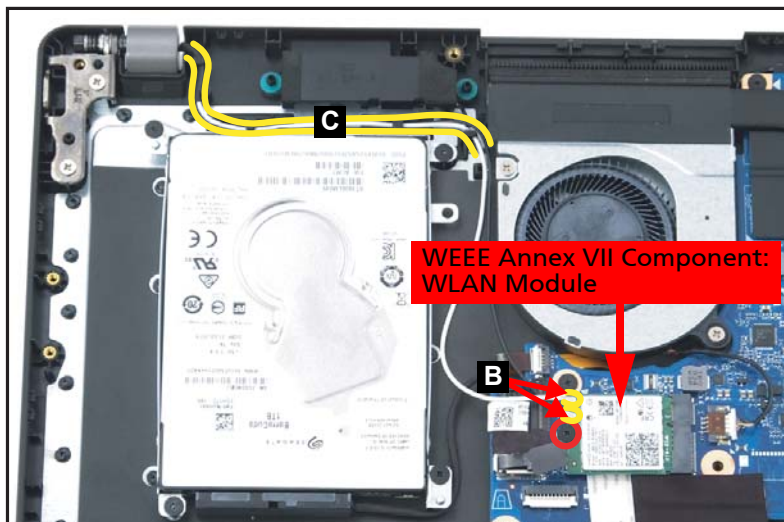
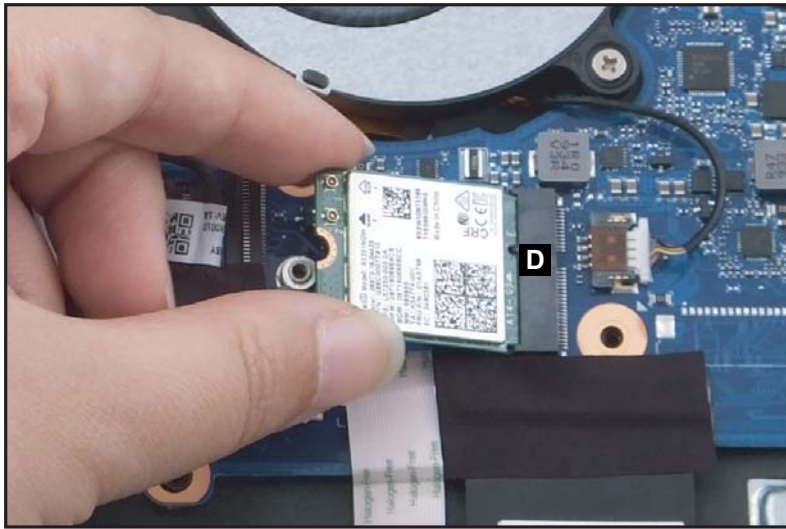

Figure 1-10. WLAN Module Removal

4. Remove the WLAN module from the mainboard connector (D) (Figure 1-11).



**Figure 1-11. WLAN Module Removal**

# DIMM Modules Removal

---

## Prerequisite:

### Battery Pack Removal

1. Find the DIMM module (A) in the system (Figure 1-12).
2. Push the DIMM module clips (B) outwards (Figure 1-12).

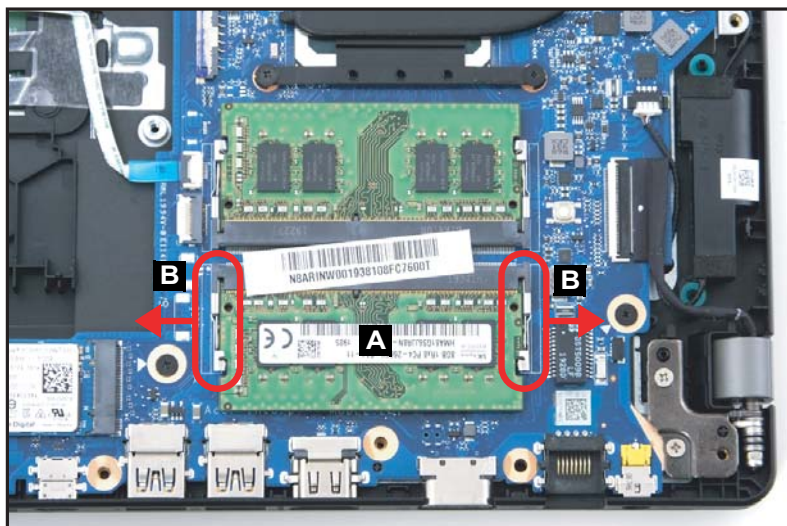

Figure 1-12. DIMM Module Removal

3. Remove the DIMM module from the mainboard connector (C) (Figure 1-13).

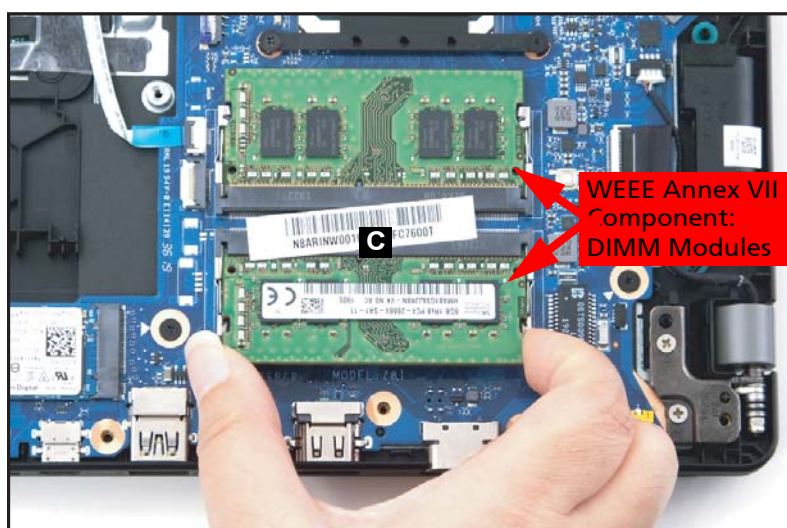

Figure 1-13. DIMM Module Removal

4. Repeat steps 1~3 to remove another DIMM module.



# SSD Module Removal

---

## Prerequisite:

### Battery Pack Removal

1. Remove one (1) screw securing the SSD module in place (Figure 1-14).



---

**Figure 1-14. SSD Module Removal**

2. Remove the SSD module (A) from the mainboard connector (B) (Figure 1-15).

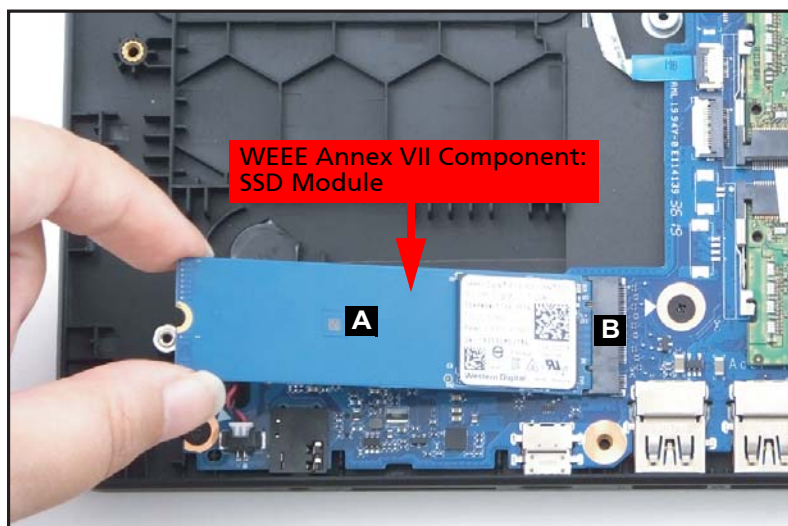

---

**Figure 1-15. SSD Module Removal**

## HDD Module Removal (HDD SKU Only)

---

### Prerequisite:

#### Battery Pack Removal

1. Disconnect the HDD cable from the mainboard connector (A) (Figure 1-16).
2. Remove four (4) screws (B) securing the HDD bracket (Figure 1-16).

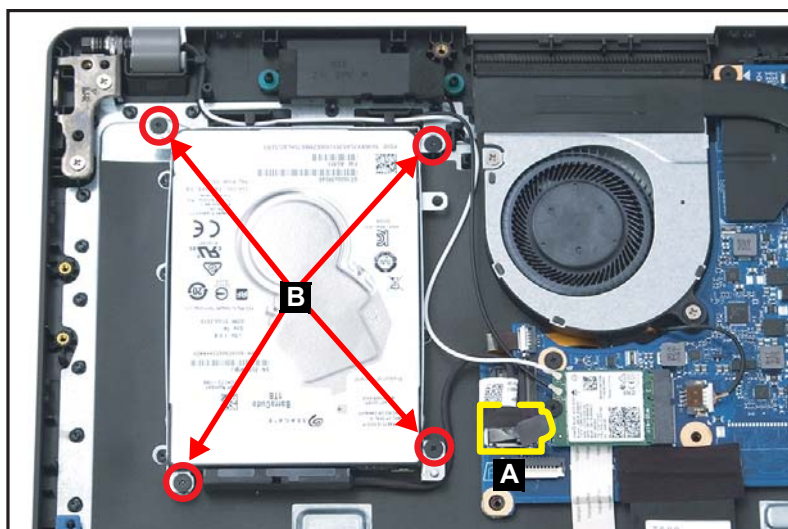

---

Figure 1-16. HDD Module Removal

3. Remove the HDD module assembly (C) from its compartment (Figure 1-17).



---

Figure 1-17. HDD Module Removal

4. Disconnect the HDD cable from the HDD module connector (D) (Figure 1-18).

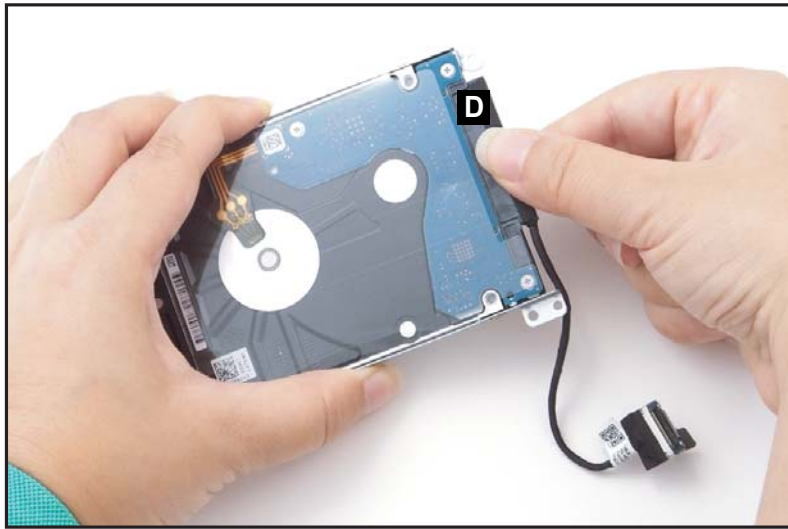

---

**Figure 1-18. HDD Module Removal**

5. Remove four (4) screws (E) from the HDD bracket (Figure 1-19).

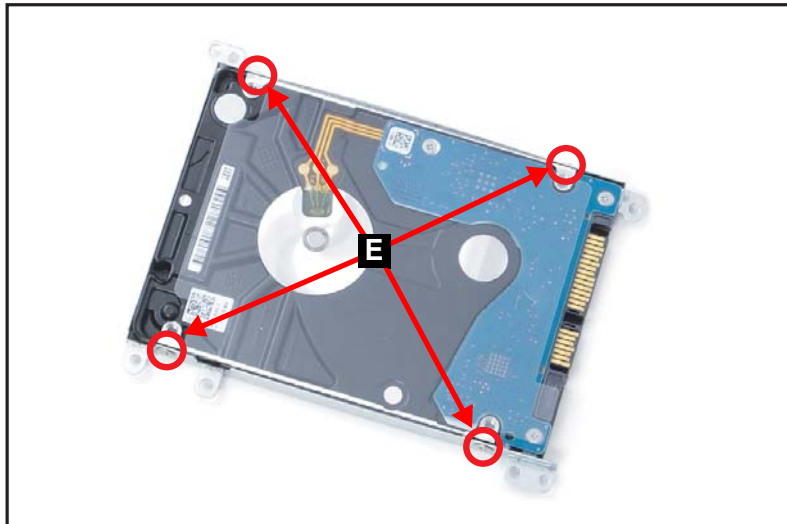

---

**Figure 1-19. HDD Module Removal**

6. Remove the HDD module from its bracket.



## LTE Module Removal (LTE SKU Only)

---

### Prerequisite:

#### Battery Pack Removal

1. Find the LTE module (A) on the top assembly (Figure 1-20).
2. Disconnect the MAIN antenna cable (blue-color) from the LTE MAIN pin (Figure 1-20).
3. Disconnect the AUX antenna cable (yellow-color) from the LTE AUX pin (Figure 1-20).
4. Remove one (1) screw securing the LTE module in place (Figure 1-20).

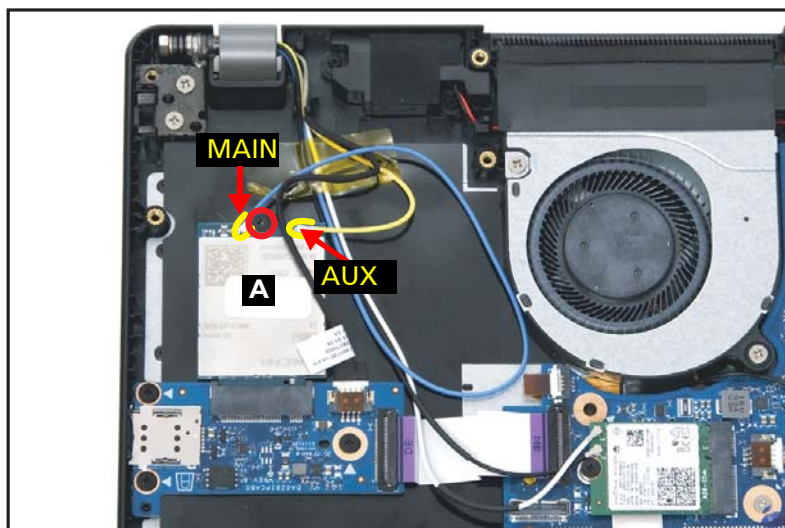

---

Figure 1-20. LTE Module Removal

5. Remove the LTE module from the mainboard connector (B) (Figure 1-21).

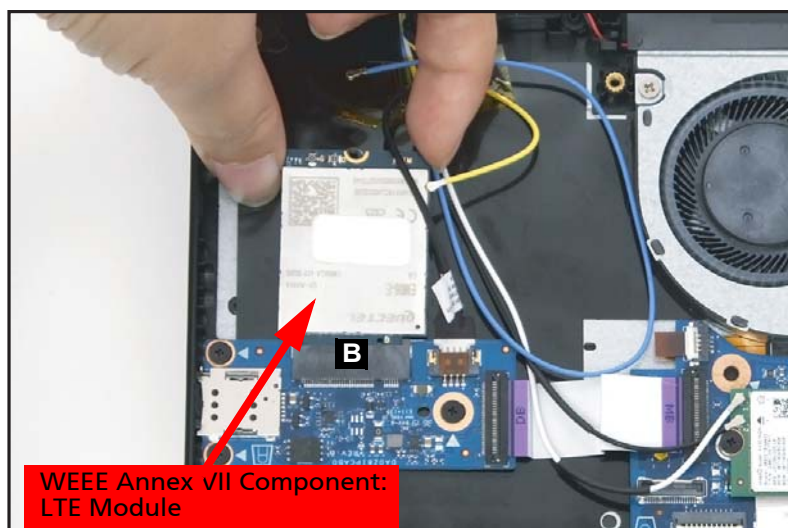

Figure 1-21. LTE Module Removal

# Touchpad Module Removal

---

## Prerequisite:

### Battery Pack Removal

1. Slightly lift the keyboard FPC, and then disconnect the touchpad FFC (A) from the touchpad module and mainboard connectors (Figure 1-22).
2. Disconnect the fingerprint FFC (B) from the touchpad module and mainboard connectors (Figure 1-22).

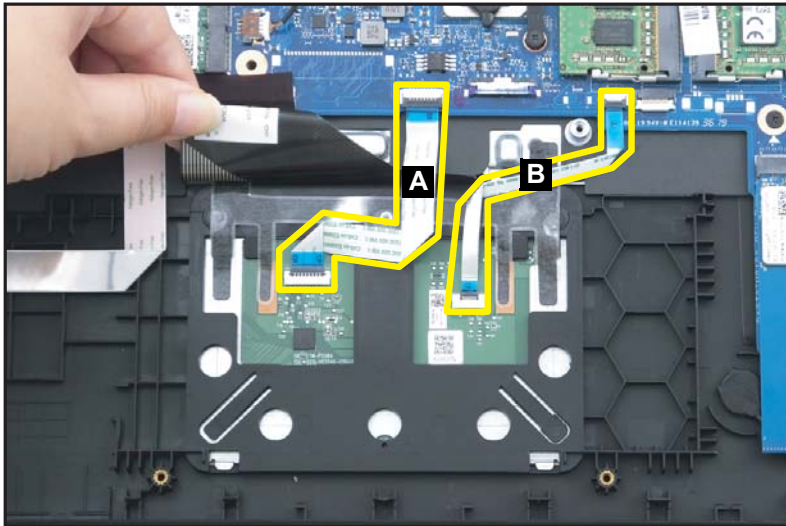

---

Figure 1-22. Touchpad Module Removal

### ⚠ CAUTION:

Touchpad FFC (Flexible Flat Circuit) and fingerprint FFC can be damaged if removed while the mainboard connectors are locked.

3. Peel off and remove the touchpad conductive tape (C) from the touchpad module and top assembly (Figure 1-23).

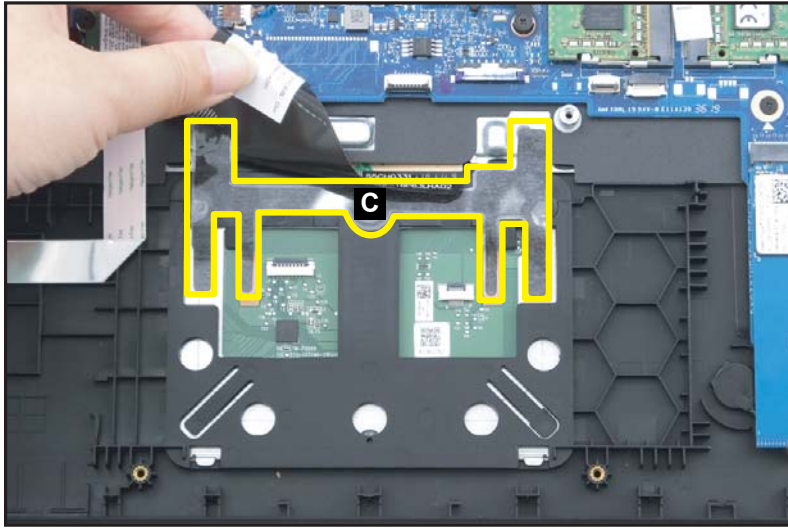

---

**Figure 1-23. Touchpad Board Removal**

4. Remove two (2) screws securing the touchpad module in place (Figure 1-24).

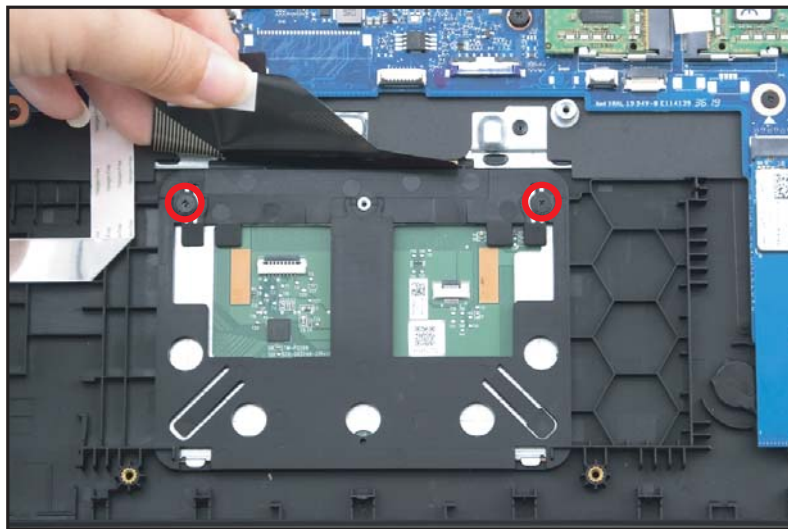

---

**Figure 1-24. Touchpad Board Removal**

5. Using the screwdriver, push the guide pins (D) firmly to release them from the top assembly (Figure 1-25).
6. With one hand is placed underneath the touchpad module, push the touchpad module slightly to disengage it from the bottom latches (E), and then remove the touchpad module (F) from the top assembly (Figure 1-25).

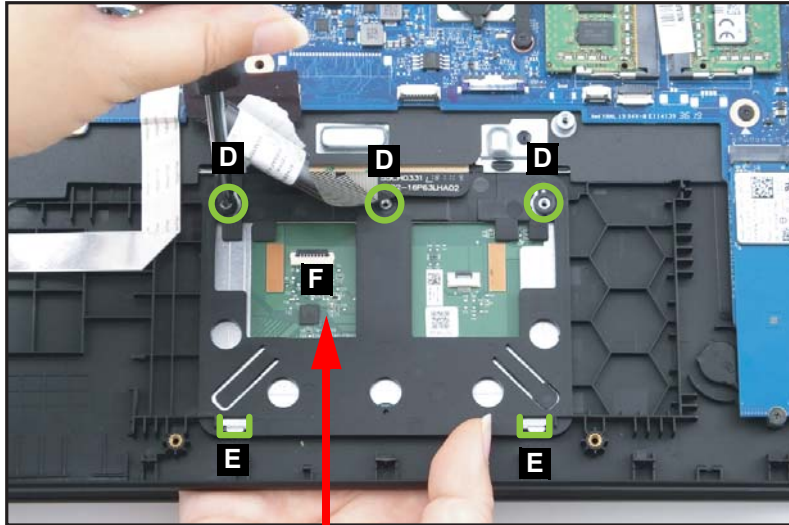

WEEE Annex VII Component: Touchpad Module

---

Figure 1-25. Touchpad Board Removal

## LCD Module Removal (HDD SKU Only)

---

### Prerequisite:

#### Battery Pack Removal

1. Disconnect the WLAN antennas cables from the WLAN module connectors (A) (Figure 1-26).
2. Remove the WLAN antennas cables (B) from the cable guides as shown in Figure 1-26.
3. Disconnect the eDP cable from the mainboard connector (C) (Figure 1-26).
4. Remove the eDP cable (D) from the cable guides as shown in Figure 1-26.

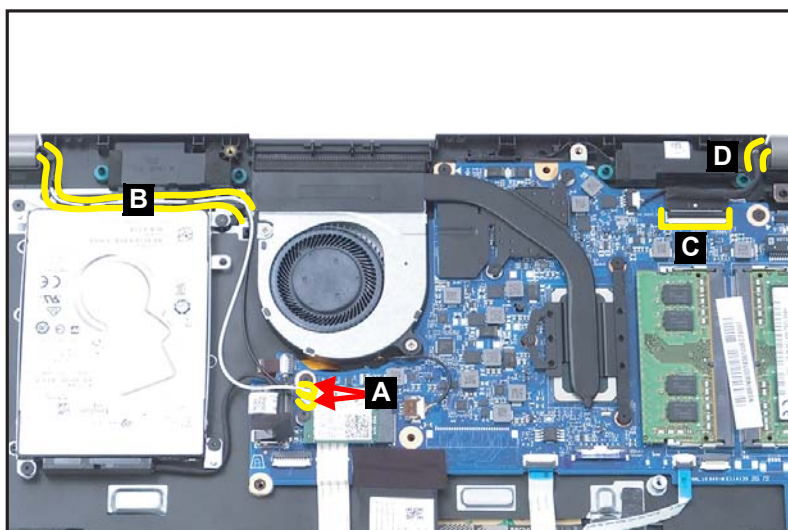
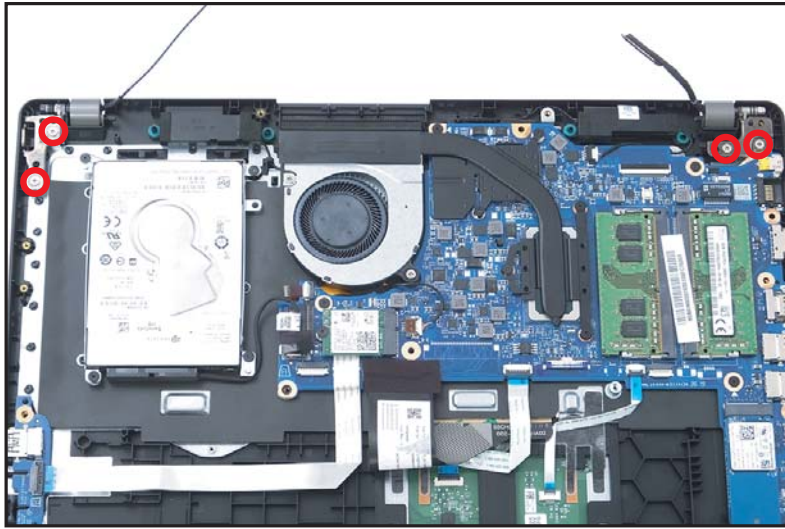

Figure 1-26. LCD Module Removal



5. Remove four (4) screws securing the LCD hinges in place (Figure 1-27).



**Figure 1-27. LCD Module Removal**

6. Lift the top assembly until it is fully open (Figure 1-28).



**Figure 1-28. LCD Module Removal**

7. Close the top assembly and lift both LCD hinges until they are fully extended (Figure 1-29).

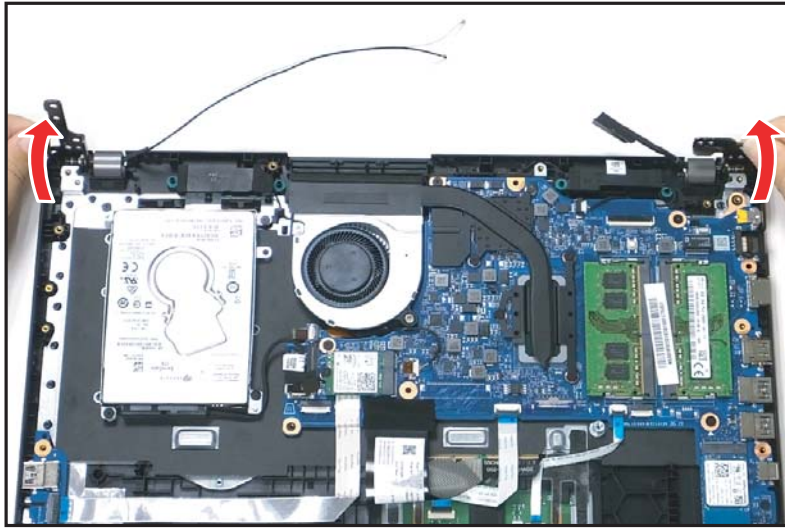

Figure 1-29. LCD Module Removal

8. Open the top assembly again, and then pull it backwards to remove the top assembly away from the LCD module (Figure 1-30).

**⚠ CAUTION:**

Make sure all cables and antennas are moved away from the device to avoid damage during removal.



Figure 1-30. LCD Module Removal



## LCD Module Removal (LTE SKU Only)

---

### Prerequisite:

#### Battery Pack Removal

1. Disconnect the tuner antenna cable from the LTE board connector (A) (Figure 1-31).
2. Unroute the tuner antenna cable from the guide on the top assembly (Figure 1-31).

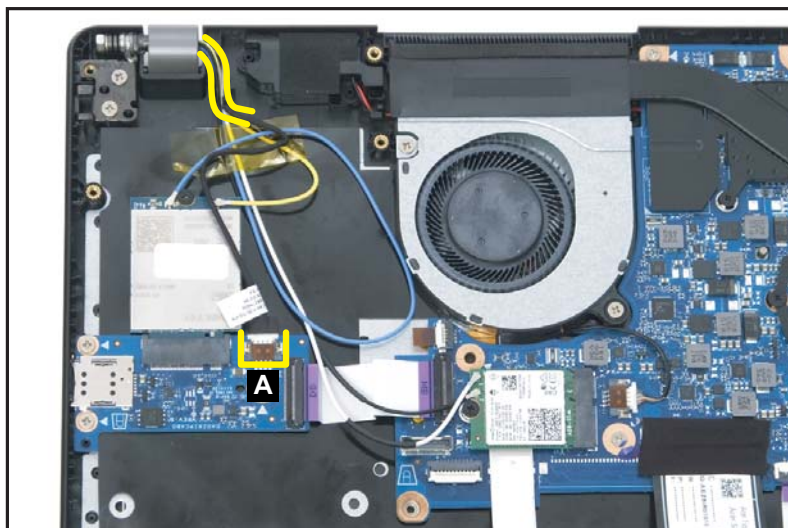

---

Figure 1-31. LCD Module Removal

3. Detach the adhesive tape from the antennas cables (Figure 1-32).

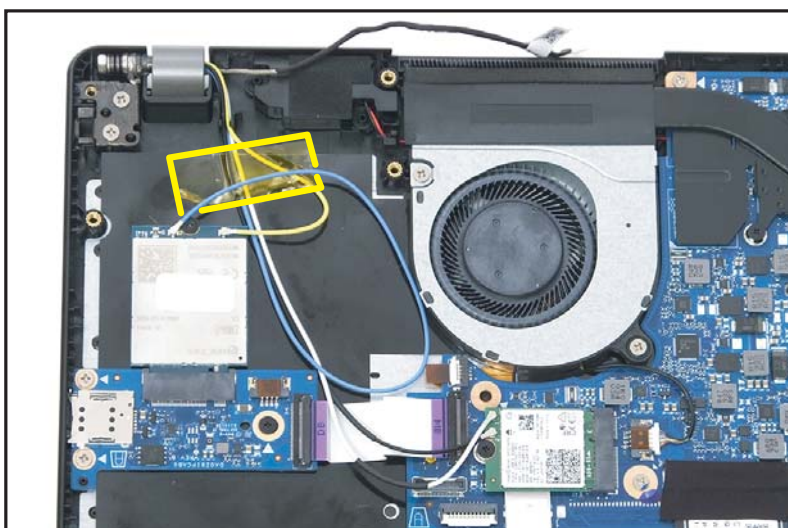

---

Figure 1-32. LCD Module Removal

4. Disconnect the LTE antennas cables (B) from the LTE module connectors (Figure 1-33).
5. Disconnect the WLAN antennas cables (C) from the WLAN module connectors (Figure 1-33).
6. Unroute the LTE and WLAN antennas cables from the guides on the top assembly (Figure 1-33).

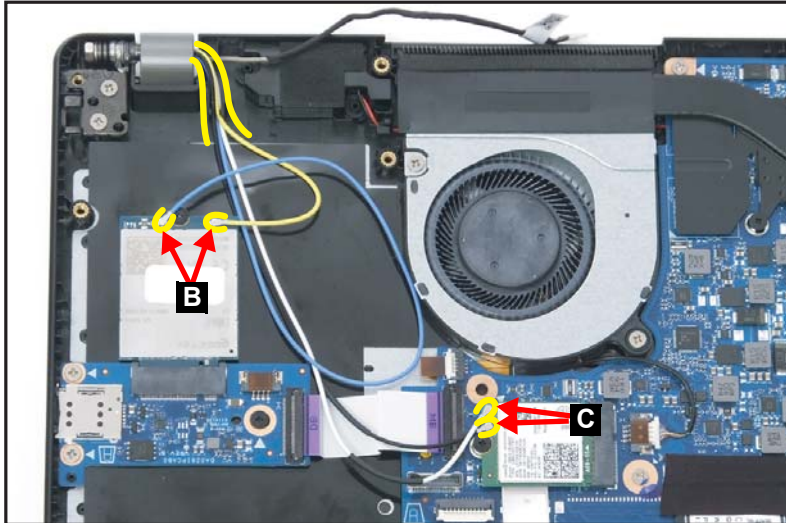

Figure 1-33. LCD Module Removal

7. Disconnect the eDP cable from the mainboard connector (D) (Figure 1-34).
8. Unroute the eDP cable from the guide on the top assembly (Figure 1-34).

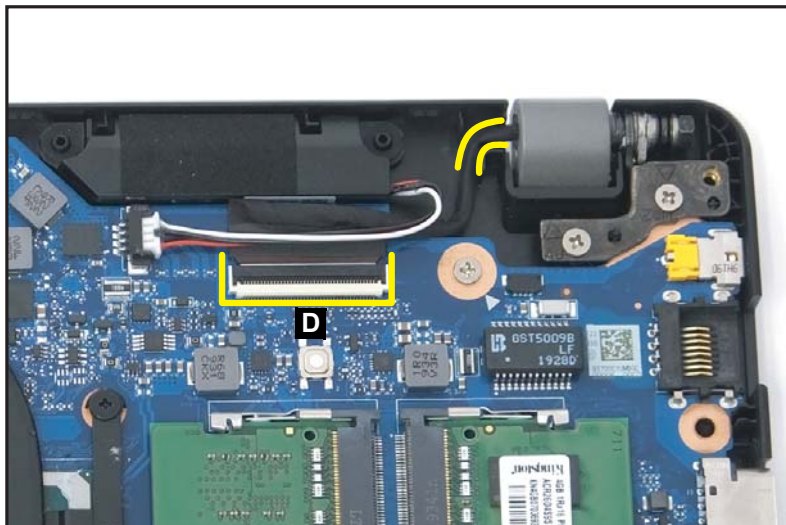
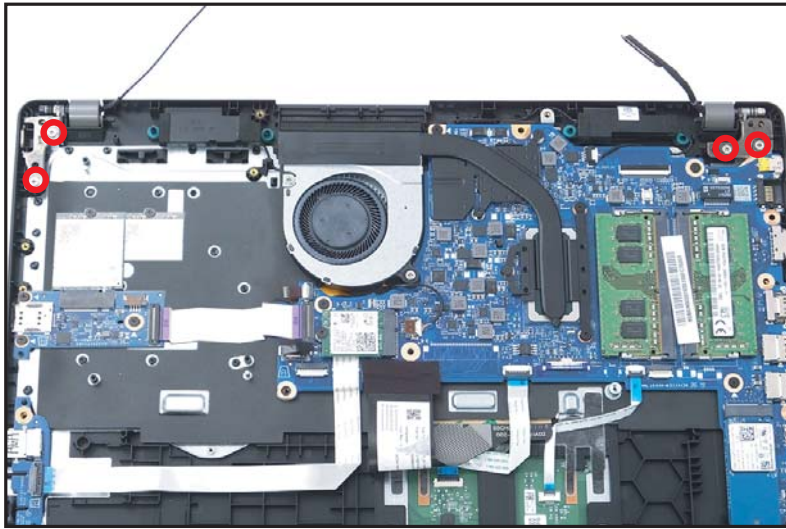

Figure 1-34. LCD Module Removal

9. Remove four (4) screws securing the LCD module in place (Figure 1-35).



**Figure 1-35. LCD Module Removal**

10. Place the device on a flat surface, top assembly facing up (Figure 1-36).

11. Lift the top assembly until it is fully open (Figure 1-36).

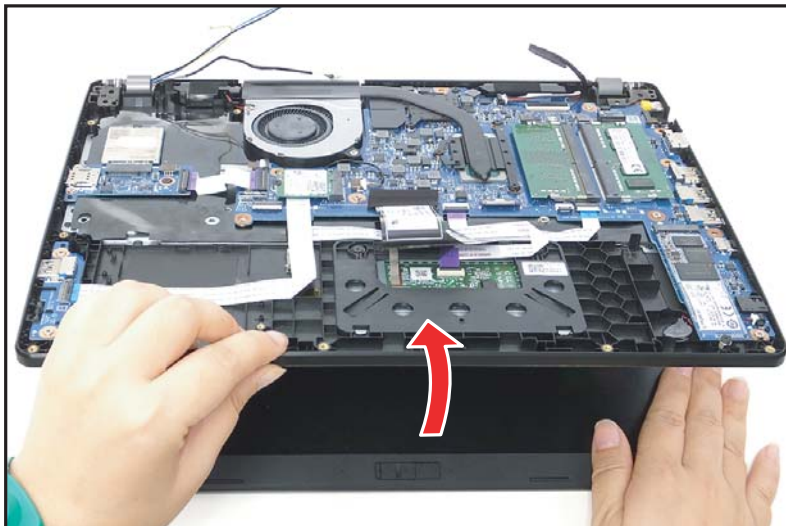

**Figure 1-36. LCD Module Removal**

12. Close the top assembly and lift both LCD hinges until they are fully extended (Figure 1-37).

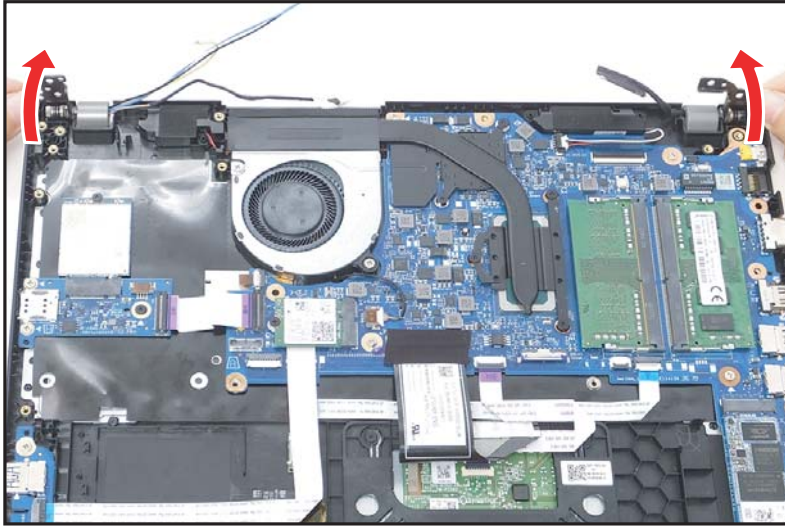

Figure 1-37. LCD Module Removal

13. Open the top assembly again, and then pull it backwards to remove the top assembly away from the LCD module (Figure 1-38).

**⚠ CAUTION:**

Make sure all cables and antennas are moved away from the device to avoid damage during removal.



Figure 1-38. LCD Module Removal



# Mainboard Removal

---

## Prerequisite:

Ensure that the **WLAN Module**, **DIMM Modules**, **Fan**, **Heatsink**, and **SSD Module** have been disassembled prior removing the mainboard.

1. Remove two (2) screws (A) securing the right side of LCD hinge in place ([Figure 1-39](#)).

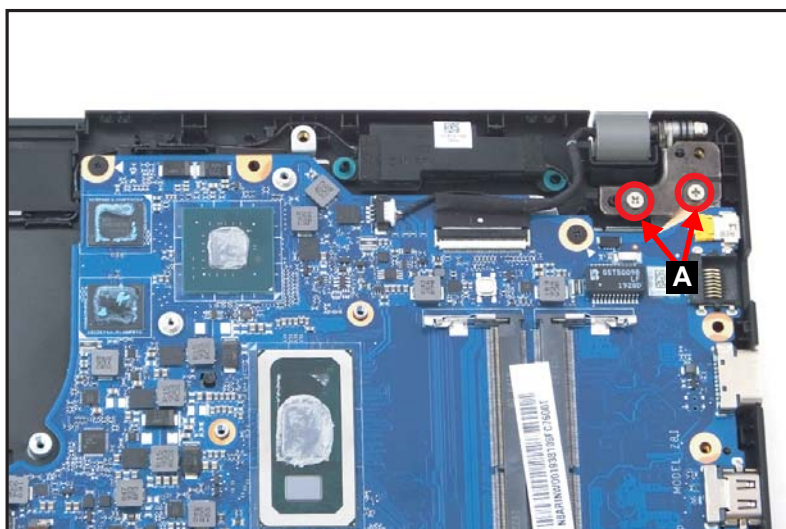

**Figure 1-39. Mainboard Removal**

2. Lift the top assembly until it is fully open ([Figure 1-40](#)).

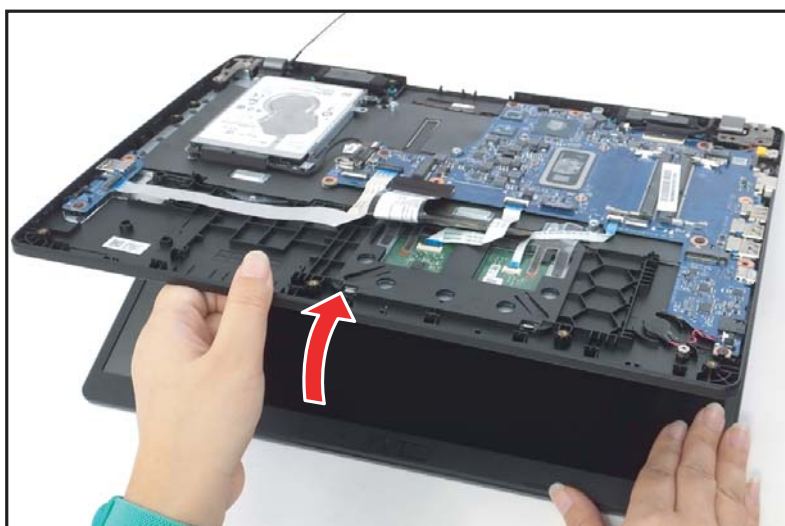

**Figure 1-40. Mainboard Removal**

3. Close the top assembly and lift the right side of LCD hinge until it is fully extended (Figure 1-41).

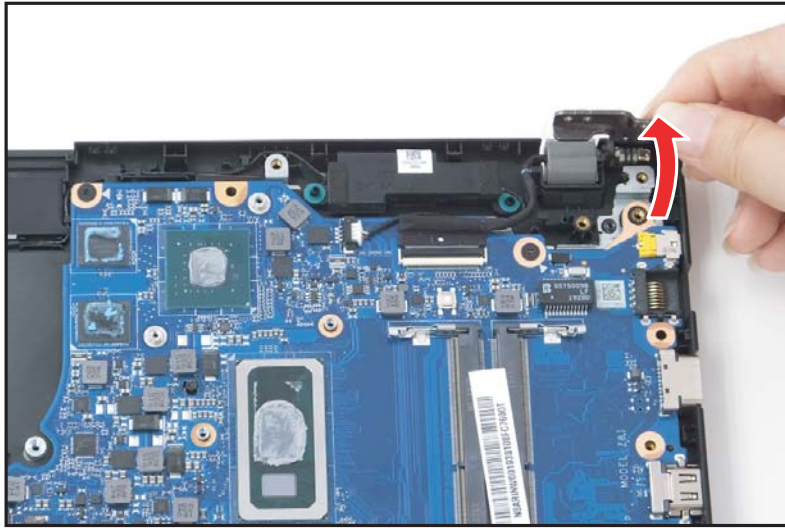

**Figure 1-41. Mainboard Removal**

4. Peel off and remove the tape (B) securing the keyboard FPC (Figure 1-42).

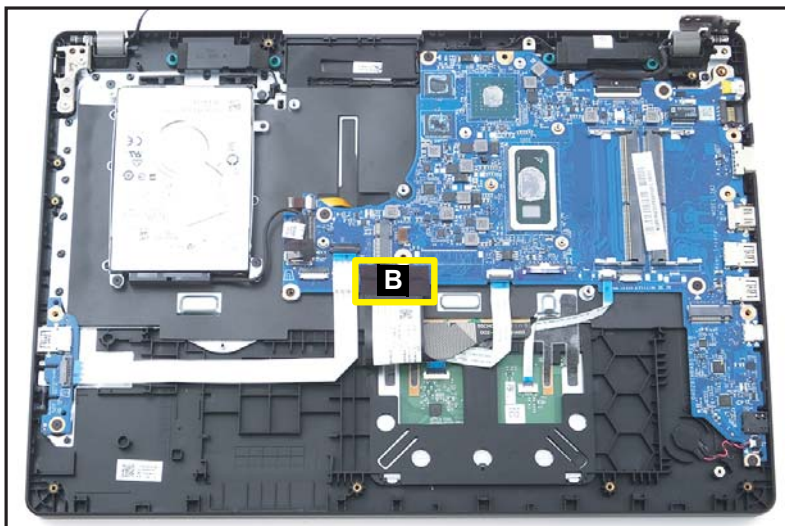

**Figure 1-42. Mainboard Removal**

5. Disconnect the HDD cable from the mainboard connector (C) (Figure 1-43).
6. Disconnect the USB board FFC from the mainboard connector (D) (Figure 1-43).
7. Disconnect the keyboard FPC from the mainboard connector (E) (Figure 1-43).
8. Disconnect the touchpad FFC from the mainboard connector (F) (Figure 1-43).
9. Disconnect the fingerprint FFC from the mainboard connector (G) (Figure 1-43).
10. Pry to detach the adhesive tape underneath the RTC battery. Then remove the RTC battery (H) (Figure 1-43).

11. Disconnect the eDP cable from the mainboard connector (I) (Figure 1-43).
12. Disconnect the speaker cable from the mainboard connector (J) (Figure 1-43).
13. Disconnect the NFC FFC from the mainboard connector (K) (Figure 1-43).
14. Disconnect the backlight FFC from the mainboard connector (L) (Figure 1-44).
15. Disconnect the LTE FFC from the mainboard connector (M) (Figure 1-44).
16. Remove seven (7) screws (N) securing the mainboard in place (Figure 1-43).

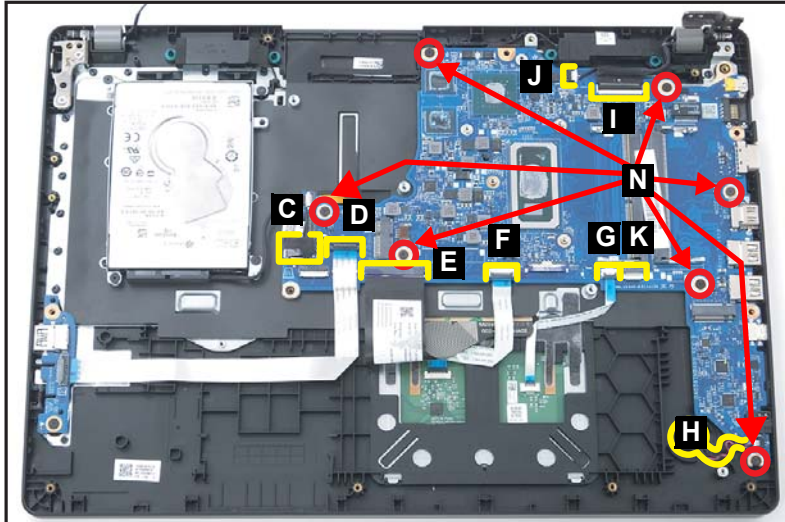

Figure 1-43. Mainboard Removal (HDD and/or NFC SKUs)

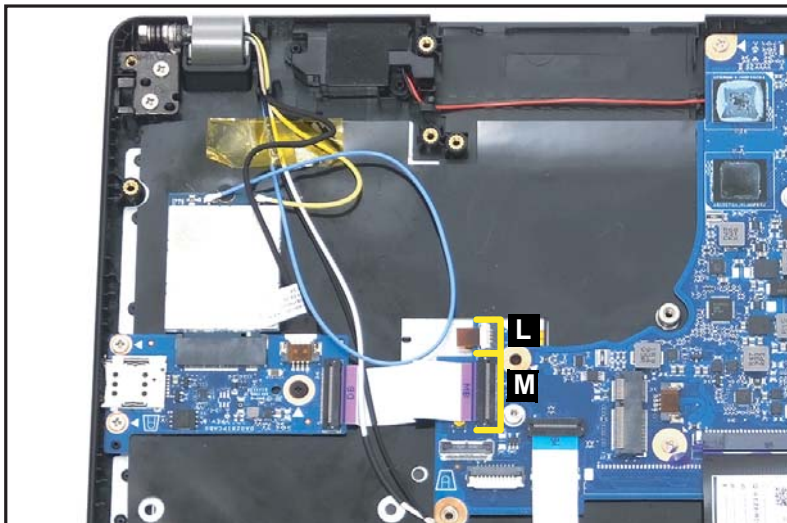

Figure 1-44. Mainboard Removal (LTE SKU)

⇒ **NOTE:**

The connected cables vary depending on the SKU.

17. Remove the mainboard (O) from the top assembly (Figure 1-45).

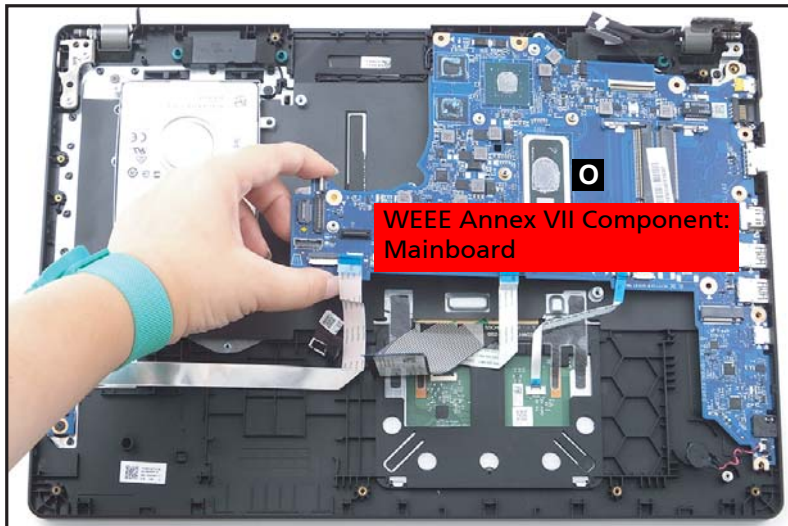

Figure 1-45. Mainboard Removal

**⚠ CAUTION:**

USB board FFC (Flexible Flat Circuit), touchpad FFC, fingerprint FFC, and keyboard FPC (Flexible Printed Circuit), can be damaged if removed while the mainboard connectors are locked.

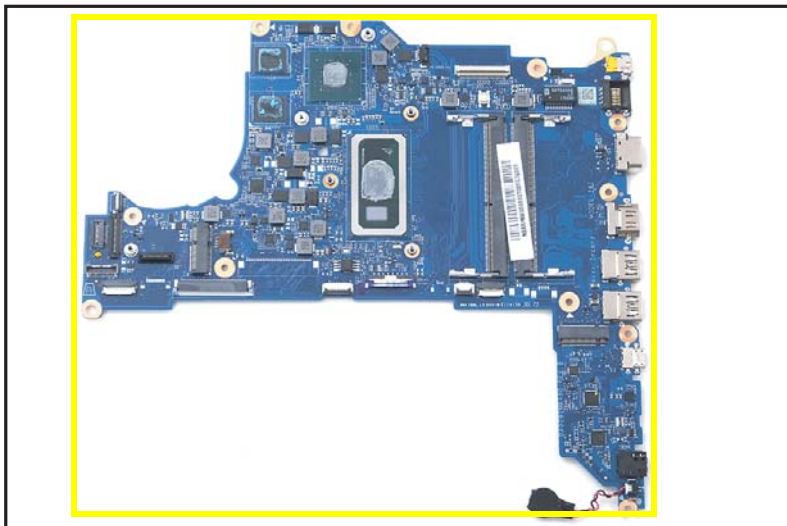

Figure 1-46. Mainboard

**+ IMPORTANT:**

Circuit boards >10 cm<sup>2</sup> have been highlighted with a yellow rectangle as shown in Figure 1-46. Remove the circuit board and follow local regulations for disposal.



# RTC Battery Removal

---

## Prerequisite:

### SSD Module Removal

1. Disconnect the RTC battery cable from the mainboard connector (A) (Figure 1-47).
2. Unroute the RTC battery cable from the cable guide (B) (Figure 1-47).
3. Using plastic tweezers, carefully pry to detach the adhesive tape underneath the RTC battery (C). Then remove the RTC battery (Figure 1-47).

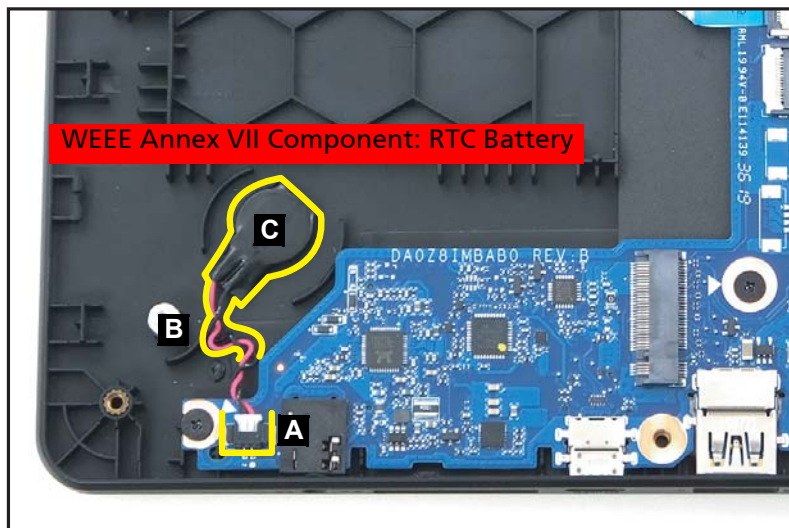

Figure 1-47. RTC Battery Removal

### + IMPORTANT:

Follow local regulations for battery disposal.

## LCD Bezel Removal

---

### Prerequisite:

[LCD Module Removal \(HDD SKU Only\)](#) or  
[LCD Module Removal \(LTE SKU Only\)](#)

1. Pry the LCD bezel from the bottom side to release latches ([Figure 1-48](#)).



---

**Figure 1-48. LCD Bezel Removal**

2. Continue along the left side of the bezel ([Figure 1-49](#)).



---

**Figure 1-49. LCD Bezel Removal**

3. Continue along the upper side of the bezel (Figure 1-50).



---

**Figure 1-50. LCD Bezel Removal**

4. Continue along the right side of the bezel until all the latches have been released (Figure 1-51). Then lift and remove the bezel from LCD module.



---

**Figure 1-51. LCD Bezel Removal**

# LCD Panel Removal

---

## Prerequisite:

### LCD Bezel Removal

1. Pry slightly to access the double-sided mounting tape (A) underneath the LCD panel (B). Then pull to detach the double-sided mounting tape from the LCD cover. Repeat the same procedure to remove the double-sided mounting tape on another side of the LCD panel (Figure 1-52).

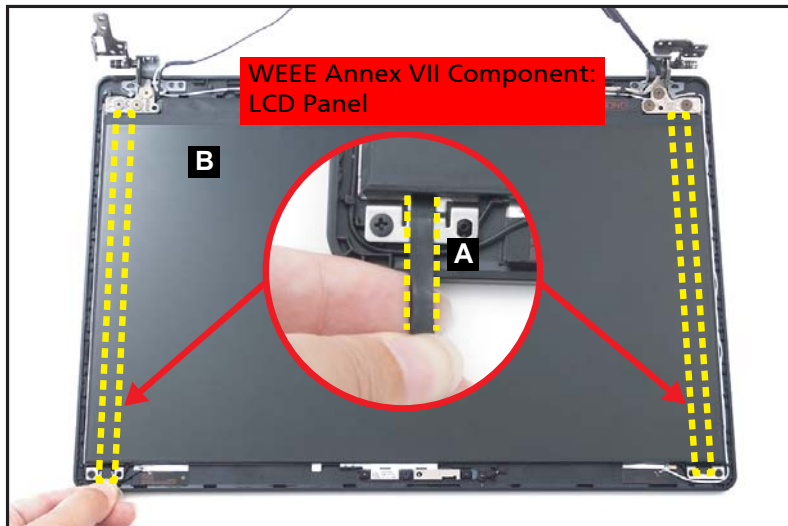

---

Figure 1-52. LCD Panel Removal

- Carefully turn the LCD panel over so that the display panel is facing down on a flat surface. Then detach the mylar tape (C) securing the eDP cable to the LCD panel (Figure 1-53).

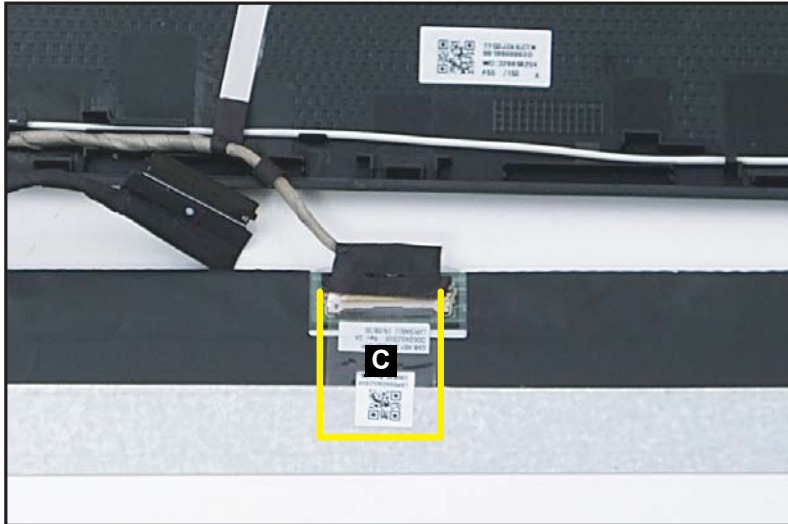

---

Figure 1-53. LCD Panel Removal

- Lift the latch (D) securing the eDP cable (Figure 1-54).

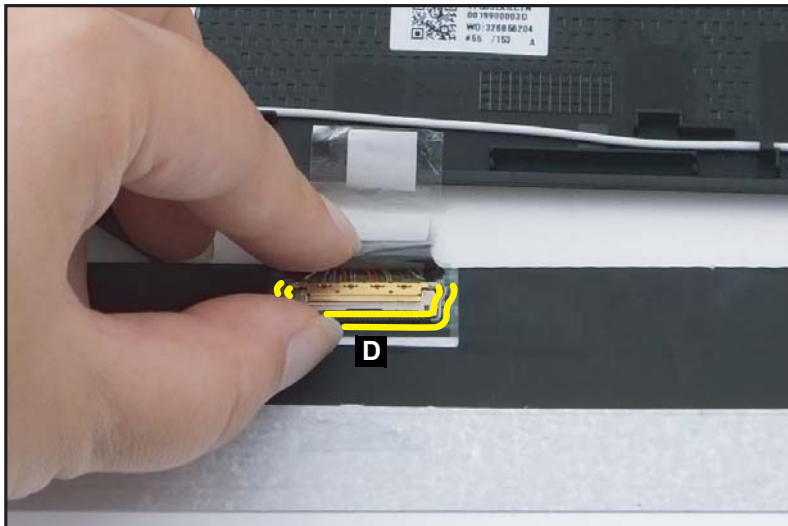

---

Figure 1-54. LCD Panel Removal

4. Disconnect the eDP cable from the LCD panel connector (E) (Figure 1-55).

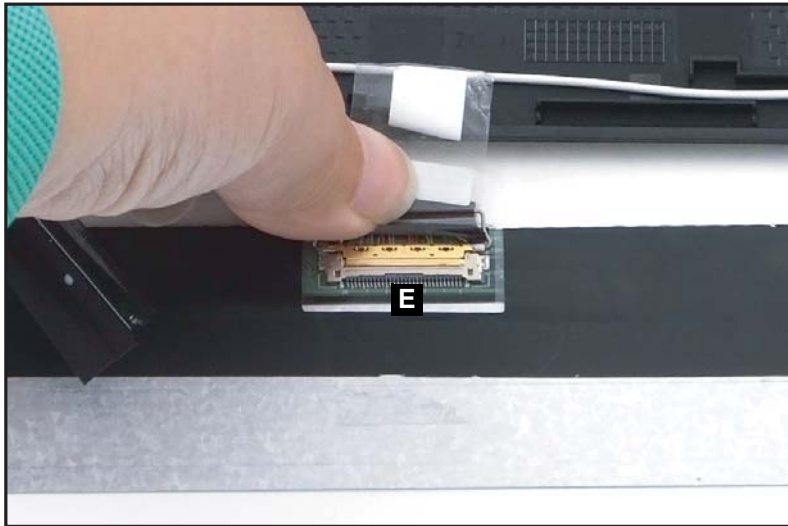

---

Figure 1-55. LCD Panel Removal

5. Remove the LCD panel.

**⚠ CAUTION:**

Make sure the eDP cable is moved away from the device to avoid damage during LCD Panel removal.

## Top Assembly Removal (Keyboard Removal)

---

### Prerequisite:

HDD SKU: Ensure that the **USB Board**, **Speakers**, **Touchpad Module**, and **LCD Module** have been disassembled prior removing the top assembly.

LTE and/or NFC SKUs: Ensure that the **USB Board**, **Speakers**, **NFC Module**, **Touchpad Module**, and **LCD Module** have been disassembled prior removing the top assembly.

### ⇒ NOTE:

The keyboard is included as part of the top assembly and can not be disassembled. In the event that the keyboard can no longer be used, replace the entire top assembly.



---

Figure 1-56. Top Assembly (Keyboard)

# Troubleshooting

---

This chapter shows you how to deal with common system problems. Read it before calling a technician if a problem occurs. Solutions to more serious problems require opening up the computer. Do not attempt to open the computer yourself; contact your dealer or authorized service center for assistance.

## Troubleshooting tips

---

This computer incorporates an advanced design that delivers on-screen error message reports to help you solve problems.

If the system reports an error message or an error symptom occurs, see “Error messages” below. If the problem cannot be resolved, contact your dealer.

## Error messages

---

If you receive an error message, note the message and take the corrective action. The following table lists the error messages in the alphabetical order together with the recommended course of action.

**Table 1-1. Error Messages**

Error Messages	Corrective Action
CMOS battery bad	Contact your dealer or an authorized service center.
CMOS checksum error	Contact your dealer or an authorized service center.
Disk boot failure	Insert a system (bootable) disk, then press <b>Enter</b> to reboot.
Equipment configuration error	Press <b>F2</b> (during POST) to enter BIOS utility, then press <b>Exit</b> in the BIOS utility to reboot.
Hard disk 0 error	Contact your dealer or an authorized service center.
Hard disk 0 extended type error	Contact your dealer or an authorized service center.
I/O parity error	Contact your dealer or an authorized service center.
Keyboard error or no keyboard connected	Contact your dealer or an authorized service center.
Keyboard interface error	Contact your dealer or an authorized service center.
Memory size mismatch	Press <b>F2</b> (during POST) to enter BIOS utility, then press <b>Exit</b> in the BIOS utility to reboot.

If you still encounter problems after going through the corrective measures, please contact your dealer or an authorized service center for assistance.



# FRU (Field Replaceable Unit) List

---

Please contact your local service center to find out how to obtain the part or replace your device.

# Exploded Diagrams

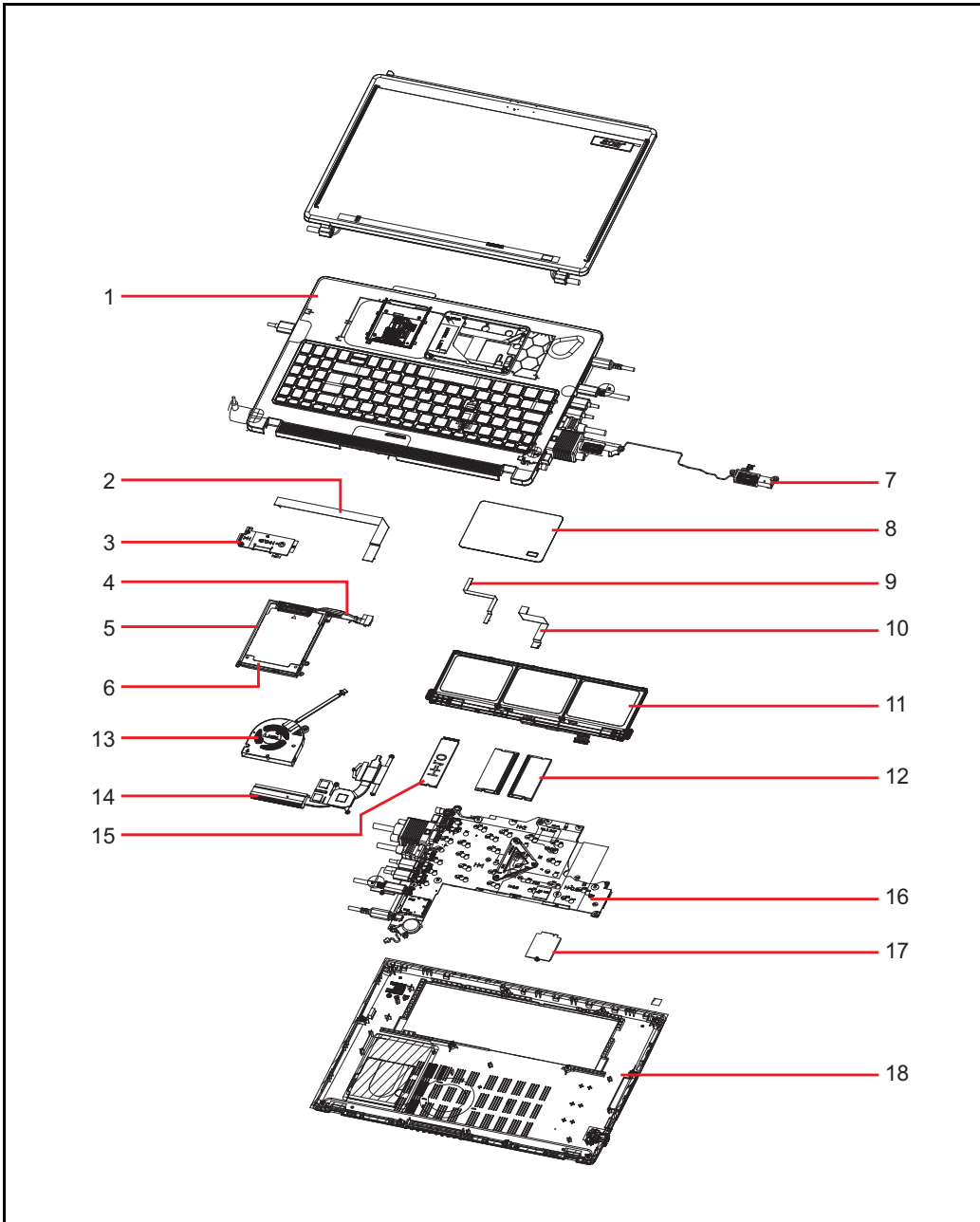

Figure 1-57. System Exploded Diagram

Table 1-2. System Exploded Diagram

No.	Description	Acer Part No.
1	Top Assembly	6B.VLKN7.001
2	USB Board FFC	50.VMNN7.002

**Table 1-2. System Exploded Diagram**

No.	Description	Acer Part No.
3	USB Board	55.VMNN7.001
4	HDD Cable	50.VLEN7.001
5	HDD Bracket	33.VMNN7.001
6	HDD Module	KH.01K01.067
7	Speakers	23.VLLN7.002
8	Touchpad Module	56.VMNN7.001
9	Fingerprint FFC	50.VLVN7.001
10	Touchpad FFC	50.VMNN7.001
11	Battery Pack	KT.0030G.020
12	DIMM Module	KN.4GB07.036
13	Fan	23.VLLN7.001
14	Heatsink	24.VLLN7.001
15	SSD Module	KN.5120D.004
16	Mainboard	NB.VLN11.002
17	WLAN Module	KE.11X0N.006
18	Base Cover	60.VMNN7.001

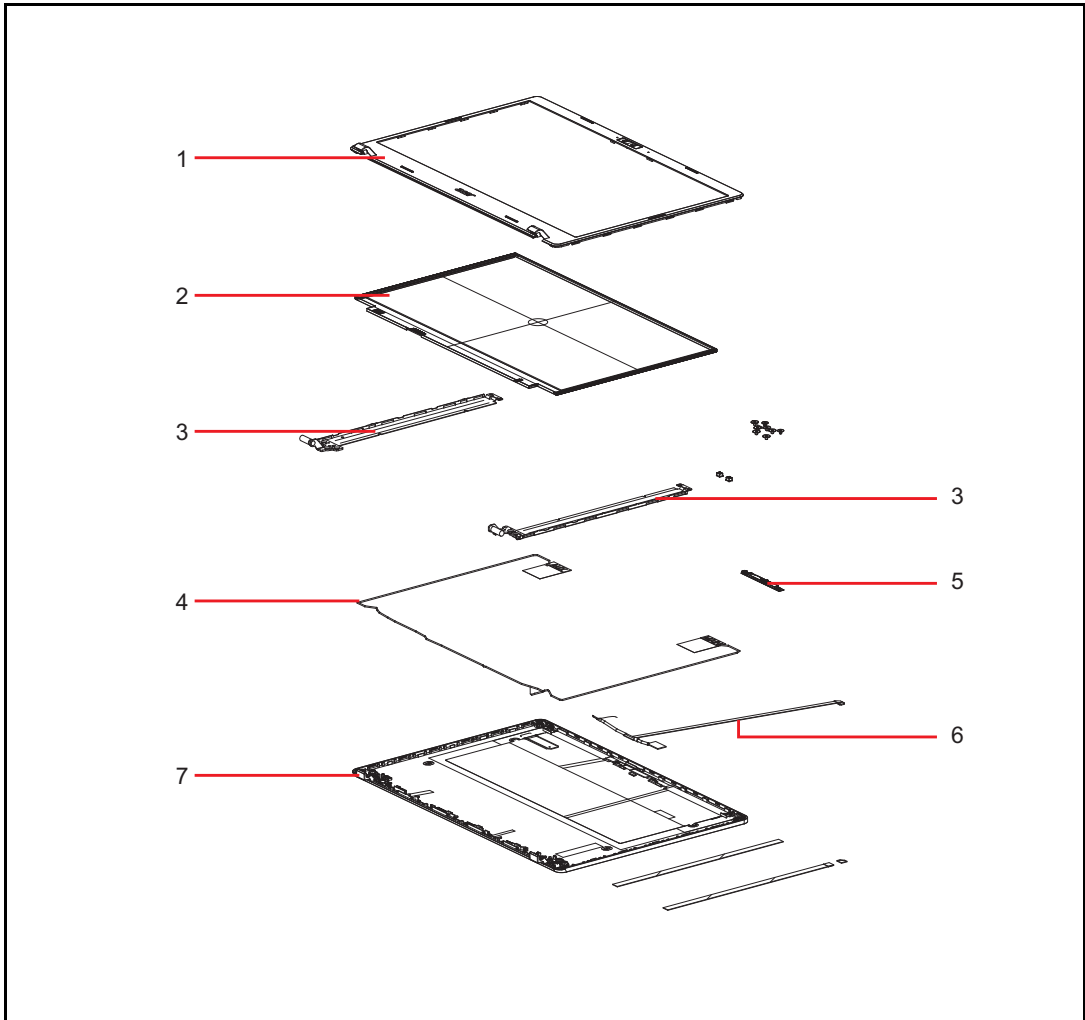

Figure 1-58. LCD Assembly Exploded Diagram

Table 1-3. LCD Assembly Exploded Diagram

No.	Description	Acer Part No.
1	LCD Bezel	60.VMNN7.003
2	LCD Panel	KL.1560D.035
3	LCD Hinge R	33.VMNN7.002
	LCD Hinge L	33.VMNN7.003
4	WLAN Antenna (MAIN+AUX)	50.VMNN7.005
5	Camera Module	KS.0HD0Q.004
6	eDP Cable	50.VMNN7.008
7	LCD Cover	60.VMNN7.002

# Software Update

---

## Updating your software

---

Please visit <http://go.acer.com/?id=17883>







# Personal Data Removal

---

## Removing your personal data

---

There are three options to choose from:

- Option 1: Select **Start**  > **Settings**  > **Update & Security**  > **Recovery**. Under **Reset this PC**, select Get started. Open **Recovery settings**.
- Option 2: Restart your PC to get to the sign-in screen, then press and hold down the **Shift key** while you select the **Power**  icon > **Restart** in the lower-right corner of the screen. After your computer restarts, select **Troubleshoot** > **Reset this PC**.
- Option 3: Select **Start** , then press and hold down the **Shift key** while you select the **Power**  icon > **Restart** to restart your computer into Recovery Mode. After your computer restarts, select **Troubleshoot** > **Reset this PC**.